

Data sheet for SIMOTICS S-1FK2

Article No. : 1FK2102-1AG11-1SA0



Figure similar

Client order no. :
Order no. :
Offer no. :
Remarks :

Item no. :
Consignment no. :
Project :

Basic motor data

Motor type	Permanent-magnet synchronous motor, Natural cooling, IP65
Motor type	High Dynamic
Static torque	0.32 Nm
Static current	0.8 A
Maximum torque	1.11 Nm
Maximum current	3.0 A
Maximum speed	8,000 rpm
Rotor moment of inertia	0.0400 kgcm ²
Weight	0.9 kg

Rated data

SINAMICS S210, 1AC 230V

Rated speed	3,000 rpm
Rated torque	0.32 Nm
Rated current	0.8 A
Rated power	0.10 kW

Encoder system

Encoder system	Encoder AS22DQC: Absolute encoder single turn 22 bit
----------------	--

Motor connection

Connection type	OCC for S210
Connector size	M12

Mechanical data

Design acc. to Code I	IM B5 (IM V1, IM V3)
Vibration severity grade	Grade A
Shaft height	20
Flange size (AB)	40 mm
Centering ring (N)	30 mm
Hole circle (M)	46 mm
Screw-on hole (S)	4.5 mm
Overall length (LB)	137 mm
Diameter of shaft (D)	8 mm
Length of shaft (E)	25 mm
Length of flange diagonal (P)	54 mm
Shaft end	Fitted key
Color of the housing	Standard (Anthracite, similar to RAL 7016)

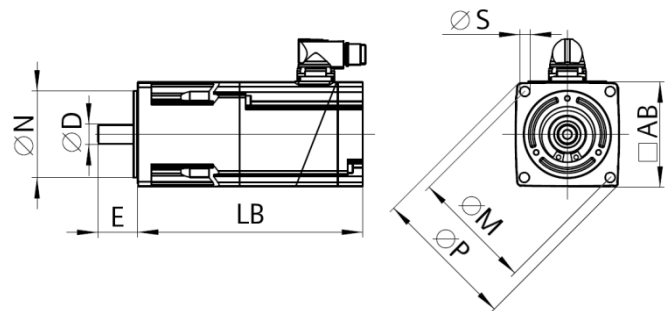

Holding brake

Holding torque	0.32 Nm
Average dynamic torque	0.32 Nm
Opening time	25 ms
Closing time	20 ms
Maximum single switching energy ¹⁾	7.4 J
Service life, operating energy	1,750 J
Holding current ²⁾	0.1 A
Break-induced current for 500 ms ²⁾	0.6 A

¹⁾Up to three consecutive emergency stops and up to 25% of all emergency stops as a Wmax high energy stop possible.

²⁾Typical value for 20°C ambient temperature. At -15°C the break-induced currents can be increased by up to 30%.